

## **INTRODUCTION**

Soyntec® thanks you for buying Soyntec® 2.1 Speakers VOIZZE™ 221. We wish you enjoy using it.

Soyntec introduce you a 2.1 multimedia speakers system for computer, with an exquisite and exclusive design. With volume and bass control, wooden body, etc. Fit your PC with the most unbelievable sound.

We recommended to read this user manual in order to enjoy the product in a safe way and with the best features.

## **CARE AND MAINTENANCE**

- Do not expose your VOIZZE™ 221 to shakes, dust, direct sun light, moisture or extreme temperatures.
- Do not use abrasive or corrosive cleaners.
- Keep the device clean and without dust with a soft and dry cloth.
- Use the power cable of your VOIZZE™ 221 in order to connect the device at the grid circuit.
- Do not disassemble the device. Any repair work must be performed by qualified Energy Sistem Soyntec's personel.
- Keep Distance to water or moisture that may be harmful to both the amplifier and speaker driver.
- Keep away from sharp object that might scratch the speaker driver and end up the service of the speaker.

## **MAIN FEATURES**

- Total output power: 10 W RMS (5W + 2.5W x2).
- Maximum output power: 100 W.
- Drive Units: 4" + 2.5" x 2.
- Frequency Response: 45 Hz - 18 KHz.
- Satellite dimensiones speaker: 80x93x125 mm.
- Subwoofer dimensions: 220x225x140 mm.
- Weight: 2.8 Kgr.

## PRODUCT CONTENT

- 2.1 Multimedia speaker.
- Power cable.
- Audio cable Jack 3.5 mm.
- User manual.

## GENERAL OVERVIEW

1. SATELLITE L.
2. VOLUME CONTROL.
3. POWER SWITCH.
4. SUBWOOFER.
5. SATELLITE R.

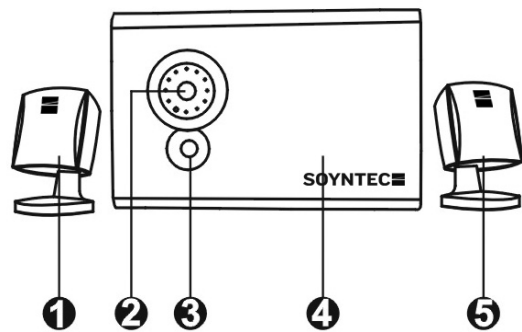

## INSTALLATION DIAGRAM

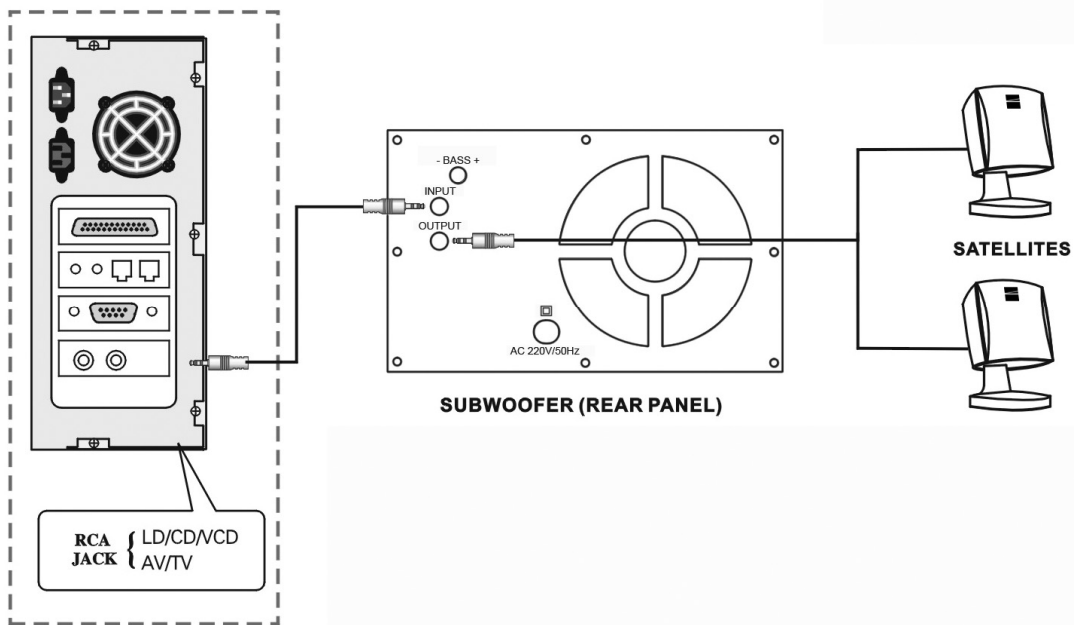

## OPERATION

- Plug the power adapter to the wall mount socket or insert into an extension.
- Insert the end satellites Jack connector into the rear side of the subwoofer (OUTPUT).
- Insert the end of the stereo plugs (mini Jack) into the INPUT in the rear of the device. Insert the other end (mini Jack) to the computer or any other player device.
- Additionally, you can insert in the rear of the device the audio cable (mini Jack) of your video games console, TV, DVD, etc.
- Switch on the speakers VOIZZE™ 221 through the switcher in the rear side of the product.
- Use the volume control in the front of the subwoofer and the bass control in the rear of the subwoofer in order to adjust the sound to your demanding level.

Any question? Check the product's F.A.Q. section at [www.soyntec.com](http://www.soyntec.com)

## WARRANTY

**Energy Sistem Soyntec S.A.** warrants its products to be free from defects in materials and workmanship at the time of purchase.

**The warranty period is 36 months** from the date of purchase for MP3 Players, Digital Cameras, Speakers, Keyboards, Mouses, Webcams, Voice over IP, PC headsets, USB Connectivity, Game controls, UPS (except for U.P.S. batteries, which have a warranty period of 24 months). In the case of Surge protection, the warranty period is **60 months**.

## GUARANTEE PROCEDURE

- 1) Visit the Support section at <http://support.soyntec.com> and select your product to view the FAQ (Frequently Asked Questions). The solution to your problem is very likely to have been already published there. You will also be able to download user manuals, user guides, drivers and updates.
- 2) If you cannot find an appropriate solution in the Support section, you may send us your enquiry or warranty service request by email: [support@soyntec.co.uk](mailto:support@soyntec.co.uk)
- 3) Alternatively, you may prefer to contact the distributor from which you purchased the product, presenting them with the receipt or invoice.

### Trademarks.

All company brand and product names are trademarks or registered trademarks of their respective companies.



## **DECLARATION OF CONFORMITY**

**Manufacturer Name:** Energy Sistem Soyntec S. A.

**Address:** Pol. Ind. Finestrat C/ Calpe Esq. C/ Alicante S/N, 03509 Finestrat  
Alicante - SPAIN

**Tel:** 902 388 388 **Fax:** 902 119 034 **NIF:** A53107488

We declare under our own exclusive responsibility that the product:

***Soyntec® 2.1 Speakers VOIZZE™ 221***

Is in compliance with the following essential directives, norms and standards of the European Union:

### **89/336/EEC (EMC Directive)**

Applicable standards:

- EN55022:1998+A1:2000+A2:2003
- EN55024:1998+A1:2001+A2:2003
- EN61000-3-2: 2000+A2:2005
- EN61000-3-3: 1998+A1:2001

**Manufacturing country:** China

**Certificate CE EMC0607066, Date 20th July 2006**